



RO 62

Características



Portas de até: 60 KG



Altura da porta: Vão interno - 35 mm



Sustentação na Base



Sistema Sobreposto



Com Rolamento



Mola Anti-descarrilamento

Sistema de sustentação na base

Aplicações

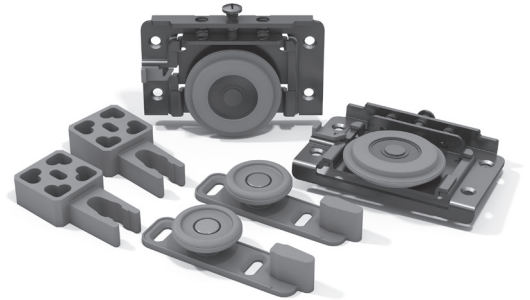

Componentes | Kit para 01 porta

Imagem	Código	Peças
	Carro Deslizante 6201	2
	Guia	2
	Freio 4005	2

Opcionais

	R-240	p. 88
	R-245	p. 89

Montagem

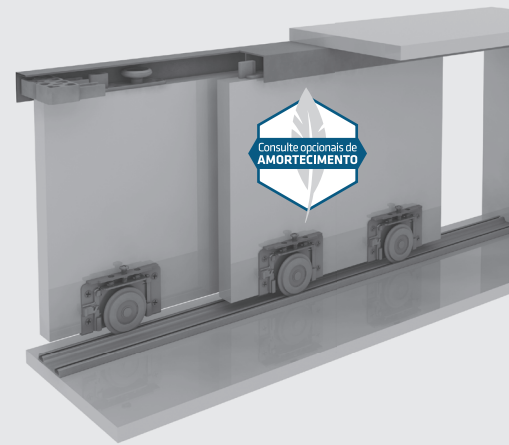
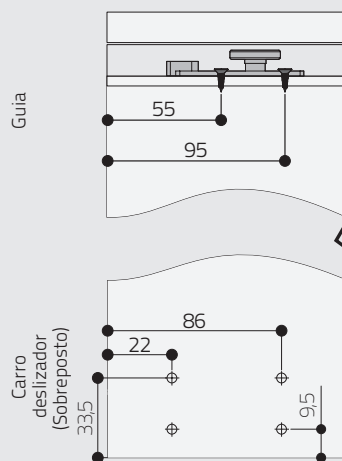

Dimensionamento (mm)

Espessuras de portas, Guias e Trilhos

Porta de 15 mm

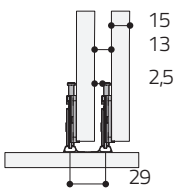

GUIA 4002
(sem rolamento)
Ø 25,8 mm

Superior (RM-013)

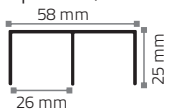

Inferior (RM-022)

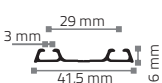

Porta de 18 mm

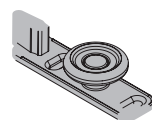
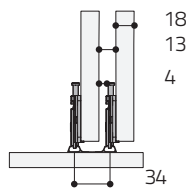

GUIA 4011
(sem rolamento)
Ø 27,8 mm

Superior (RM-025)

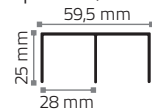

Inferior (RM-023)

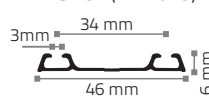

OBS: Optando por outras composições do sistema, ou espaçamentos entre portas diferentes dos apresentados, consultar opcionais de guias e trilhos nas páginas finais deste catálogo ou entrar em contato com o Comercial Rometal.

Porta de 20 mm

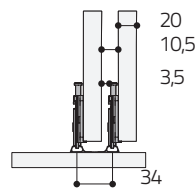

GUIA 4011
(sem rolamento)
Ø 27,8 mm

Inferior (RM-023)

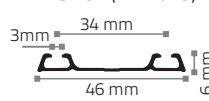

Porta de 22 mm

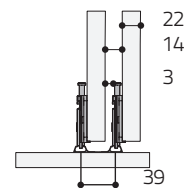

GUIA 4012
(sem rolamento)
Ø 31,8 mm

Superior (RM-038)

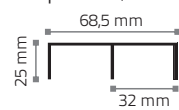

Inferior (RM-034)

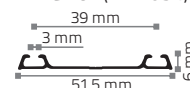

Porta de 25 mm

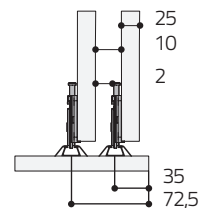

GUIA 4012
(sem rolamento)
Ø 31,8 mm

Superior (RM-038)

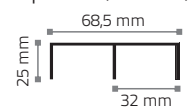

Inferior (RM-027)

