

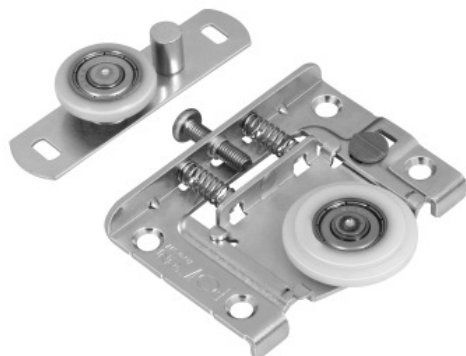

Rodízio SD 601



- Descrição:** Rodízio composto de deslizador inferior e guia superior com rolamento 626 blindado e batente trava em plástico. Permite a regulação da porta em 5 mm.
- Material:** Aço laminado / componentes plásticos em nylon / rolamento 626 blindado revestido em poliacetal
- Acabamento:** Zincado eletrolítico cromatizado azul
- Fixação:** Parafusos cabeça panela autocortante PHS 3,5x14mm e 4x25mm
Parafuso cabeça chata autocortante PHS 4x16mm
- Capacidade:** 60 kg por porta
- Observações:** Acompanha kit de fixação e instruções de montagem.

Componentes

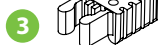
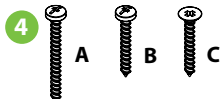

- 1 Deslizador inferior (2x)
- 2 Guia superior com rolamento (2x)
- 3 Batente freio (2x)

- 4 A - Parafuso cabeça panela autocortante PHS 4x25 mm (2x)
- B - Parafuso cabeça panela autocortante PHS 3,5x14 mm (4x)
- C - Parafuso cabeça chata autocortante PHS 4x16 mm (8x)

| Código | Descrição | Embalagem |
|--------------|---------------------------------|-----------|
| 0086.060001 | Kit Rodízio SD 601 | 15 kits |
| 0086.0600011 | Kit Rodízio SD 601 (Industrial) | 50 kits |

1 - Encaixar a porta no trilho superior e girá-la, alinhando-a com o trilho inferior. Com a roldana encaixada no trilho inferior, libere-a utilizando a trava do mecanismo.

2 - Com o auxílio de uma chave *philips*, regular o nivelamento da porta utilizando o parafuso vertical montado no deslizador inferior.

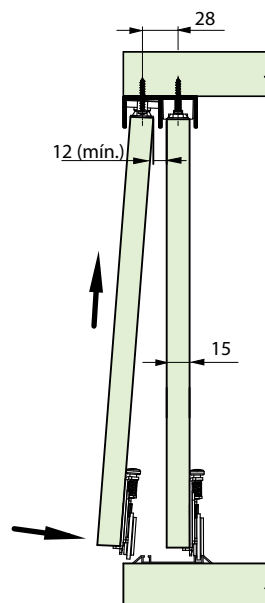
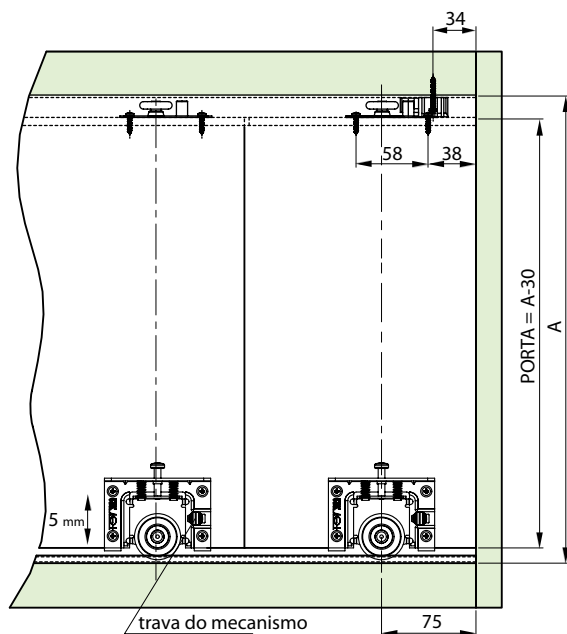

Trilhos:

Superior

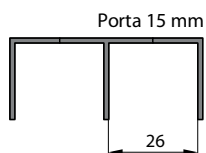

Inferior

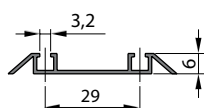

Montagem do trilho superior e instalação do batente freio

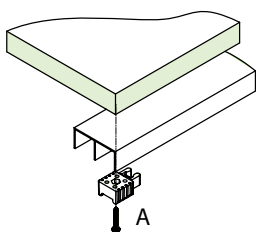

Montagem do deslizador superior no topo da porta

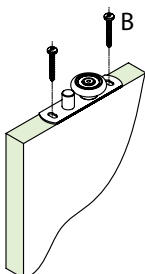

Furação para instalação do deslizador inferior na porta

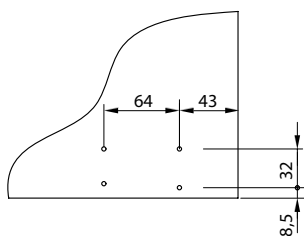

Instalação do deslizador inferior na porta

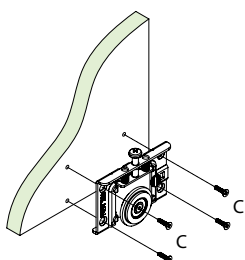

Sistema de montagem

